

AN APPROACH FOR INDUSTRIAL APPLICATION OF AXIOMATIC DESIGN

Weber, Jakob (1); Kößler, Johannes (2); Paetzold, Kristin (2)

1: Daimler AG, Germany; 2: Universität der Bundeswehr München, Germany

Abstract

This paper presents an Axiomatic Design based approach which aims to simplify the application of this methodology in everyday working life of engineers. As a basis Axiomatic Design Theory is chosen because of its clear representation of dependencies of functional requirements. This provides a good control for designers if their design maintains functional independence and therewith the principles of good design. Based on the original methodology a new shortened procedure has been developed. The focus of this procedure has been set on applying Suh's independence axiom on the most abstract levels during decomposition of the design task. The presented procedure is meant either as first steps into a complex design methodology or as a kind of approximation in early design phases. This approximation can be detailed to a full Axiomatic Design approach during the following design steps. The effects of using this shortened approach have been evaluated by carrying out a common design task. Finally the results of this evaluation have been discussed critically.

Keywords: Axiomatic Design, Design methodology, Early design phases

Contact:

Jakob Weber
Daimler AG
TF/VFT
Germany
jakob.weber@daimler.com

Please cite this paper as:

Surnames, Initials: *Title of paper*. In: Proceedings of the 20th International Conference on Engineering Design (ICED15), Vol. nn: Title of Volume, Milan, Italy, 27.-30.07.2015

1 INTRODUCTION

Nowadays companies are exposed to competition more than ever. The reasons for that are versatile, beside shortened product lifecycles and with it a higher demand of customized products, in particular globalization plays a vital role. The consequences of these circumstances are shorter development times and increasing cost pressure not only for the products but also for the required machinery and equipment. Especially this applies to the automotive industry. While in the past the product portfolio of the companies was restricted to a certain market segment, e.g. upper class models, in which the model update took place after several years, now the companies provide a large product portfolio ranging from small cars up to the premium class and this within significantly shorter lifecycles. In order to be successful a systematic approach is necessary in the development and manufacturing of the new products.

1.1 Problem Definition

On the one hand the design process in industrial companies is often based on empirical knowledge, sometimes it is not even established on structured procedures. On the other hand there are many design methodologies with reasonable good approaches that could help to improve the design process. Unfortunately for the majority of cases the provided methodologies are too complex and seized. Furthermore the learning of a methodology can be time-consuming. Therefore there is frequently a contradiction between the demand for a suitable approach for solving design tasks on the one side and the offer of advantageous but elaborate methodologies on the other side.

1.2 Definition of Objectives

The main objective of this paper is to present an appropriate design methodology which can be modified and simplified in such a manner that it can be easily applied in everyday business life. As basis the “Axiomatic Design (AD) Theory” invented by Suh (1990, 2001) is used because of its clearly structured approach and its presentability of the design’s functional independence. The latter is particularly relevant for the designer as it provides a kind of self-control checking if he is on the right path to a good design.

In this paper a shortened approach for a design methodology on the basis of AD is proposed and a use case based on this approach is presented. The research questions are:

1. How can a modification of AD look like in order to make it easily applicable in industry?
2. Are some sorts of effects using the proposed procedure identifiable?

2 STATE OF THE ART AND RELATED WORK

An overview of American and European approaches to design is given in (Tate, 1995). Important design methodologies are the Theory of Inventive Problem Solving (TIPS) by Altshuller (1988), the concept of Hubka and Eder (1992), Characteristics-Properties Modelling and Property-Driven Development (CPM/PDD) by Weber (2005) and finally Axiomatic Design by Suh (1990, 2001). These are only a few of them, listing all of them would go beyond the scope of this paper. Common to the majority of design methodologies is the principle to maintain the independence of the functions of the desired product in order to guarantee a robust design. Further in most of the design methodologies the design process is circumscribed as a two steps procedure consisting of an analysis and a synthesis which may be executed iteratively. The reason for restricting on AD in the following is in particular based on the fact that AD provides an explicit and clear representation of dependencies of functions beside the mentioned analysis and synthesis steps. In the following the principles of AD are explained and an overview of industrial applications without any claim to completeness is given.

2.1 Axiomatic Design

In his Axiomatic Design Suh formulated a design methodology using a classical “top-down” approach to decompose a design task. The theory is mainly based on two axioms. The first axiom is the independence axiom. This axiom says that the independence of the functional requirements demanded for a product has to be maintained by choosing appropriate design parameters that characterize the later product. The second axiom is the information axiom. This axiom says that the best design solution needs least additional information to fulfil the specified requirements. At each step of

decomposition these axioms are applied. Both the decomposition and the two axioms are explained more detailed in the following sections.

2.1.1 Decomposition of the Design Task

One of the advantages of using AD is the hierarchical approach to a design task. In (Suh, 1990) and (Suh, 2001) the design process is formulated as a mapping of functional requirements (FRs) from the functional domain to design parameters (DPs) in the physical domain. First this mapping takes place on the most abstract top level. The design parameters stated on this top level influence the FRs of the secondary and therewith more specific level. Again the FRs are mapped to the design parameters and so on. This repeating switching between the two domains is called “zigzagging”. It is a continuous alternating between the questions “what we want to achieve” and “how we want to achieve it” while getting more and more specific. Inspired by Mann (2002) the hierarchical nature of AD is shown in Figure 1.

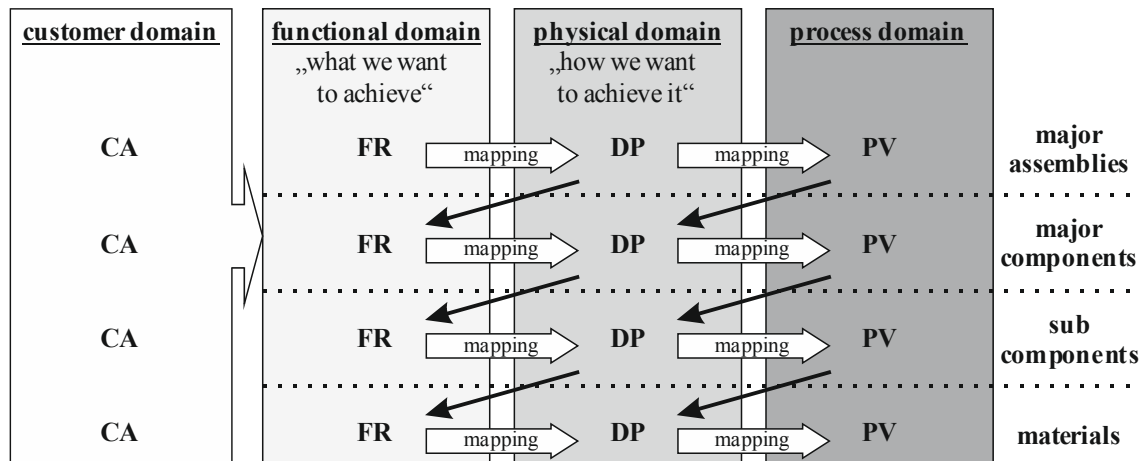

Figure 1. Hierarchical “top down” approach of AD

In (Suh, 1990, 2001) two further domains are mentioned. In the customer domain the customer attributes (CA) are defined and are mapped to FRs. After mapping the FRs to DPs, the DPs are mapped to so called process variables (PVs) in the process domain. These are variables that describe the manufacturing of the product designed in the physical domain.

2.1.2 The Axioms in Axiomatic Design

There are two axioms formulated in AD to make the right decisions regarding the selection of DPs. As already mentioned, the first one is the independence axiom formulating the necessity of keeping the FRs independent by choosing the DPs properly. This axiom can be visualized by formulating mathematically the mapping between FRs and DPs. Provided that there are linear dependencies between FRs and DPs, the FRs and DPs are summarized to vectors that are linked by the so called design matrix (Figure 2). According to Suh a design is optimal if the FRs are kept independent. This means there is exactly one DP for each FR. Adjusting this DP only affects the appertaining FR. This means the design matrix should be a diagonal matrix.

$$\begin{Bmatrix} FR_1 \\ FR_2 \\ FR_3 \end{Bmatrix} = \begin{bmatrix} A_{11} & A_{21} & A_{31} \\ A_{12} & A_{22} & A_{32} \\ A_{13} & A_{23} & A_{33} \end{bmatrix} \begin{Bmatrix} DP_1 \\ DP_2 \\ DP_3 \end{Bmatrix}$$

Figure 2. FRs are linked to DPs through the design matrix A

Consequently only such DPs should be chosen which maintain this independency. If there are two solutions with diagonal matrices axiom two should be applied. This axiom claims that the best solution is that with minimum additional needed information to fulfil the demanded FRs. In other words this means the solution with the higher probability of success should be preferred. Therefore the information content of both solutions has to be calculated according to Equation 1 where P is the probability of a DP fulfilling the FR.

$$I = \log_2 (1/P) \tag{1}$$

A detailed explanation of the calculation of information content in AD is given in (Shin et al., 2004).

2.2 Industrial Applications of Axiomatic Design

There are already several applications of AD in the industry. Because of the very abstract nature of AD, the theory is applicable to highly diverse industries ranging from classical mechanical engineering over supply chain design (Baxter et al., 2002) and architecture (Marchesi et al., 2014) to developing of electronic commerce strategies (Martin and Kar, 2002). Furthermore Nordlund et al. (1996) give an overview of several applications. Many more use cases of AD theory are known which cannot be mentioned within this paper. All of these applications use the complete procedure proposed in AD. None of these approaches simplify the theory in such a way proposed within this paper.

Nevertheless these manifold applications prove the universal applicability of AD which Suh stresses in (Suh, 1990, 2001). This universality also contributes to the attractiveness of AD to industrial companies.

3 THEORETICAL CONSIDERATIONS

As stated in the introduction it has to be clarified how a simplification of AD can be carried out. Axiomatic Design is a very powerful but also sophisticated theory of design. This complexity makes it difficult to beginners to find a starting point and to apply AD in everyday work life. For this reason the consideration of this paper is to simplify the procedure in such a way that it becomes easy to understand.

Under the assumption that especially the information axioms provides some troubles for understanding and that calculating the information content is the biggest effort, this is a starting point to simplify the methodology. On the left side of Figure 3 the original AD flowchart is presented. As already outlined in chapter 2 the process starts with analysing the design task and proposing a solution. With this constraints (C) of the design are defined. These constraints can be handled similar to FRs but with the exception of being valid on all hierarchical levels. In the following process the proposed design is checked by applying the independence axiom. If this axiom is violated other DPs have to be chosen. In the other case of satisfying the axiom nevertheless other DPs are formulated. If the result is that there is more than one design with the same degree of independence, the information axiom is used to make a decision. After this the process is stopped with the result of achieving the presumed best design.

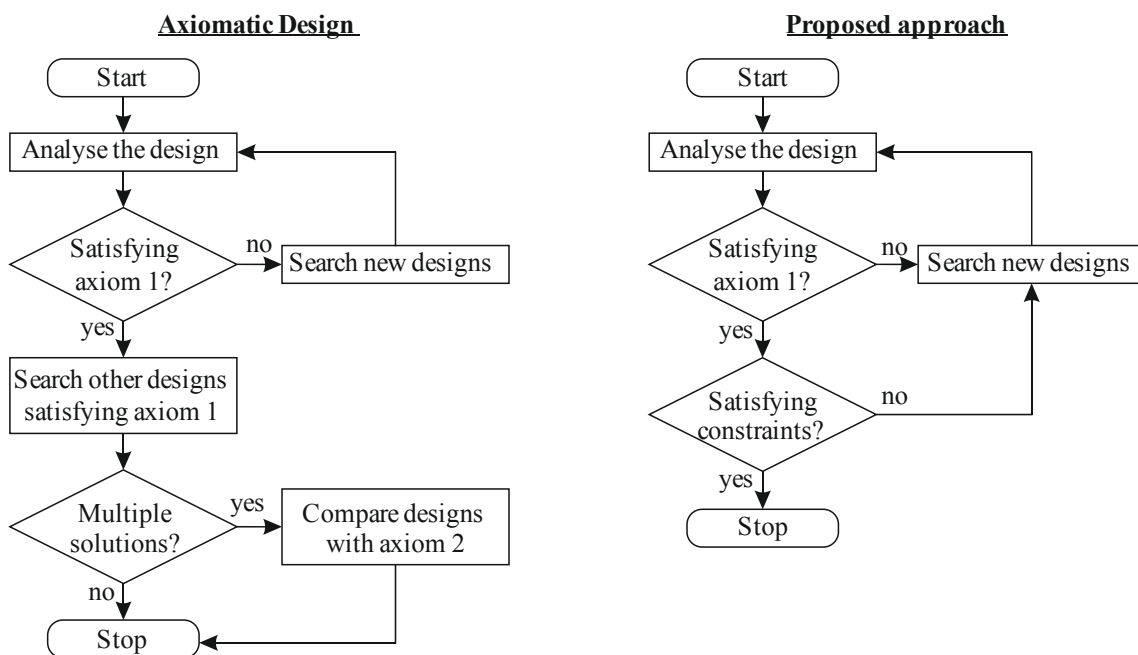

Figure 3. Flowchart of AD and of the proposed approach

On the right side the proposed and simplified flowchart is shown. After checking if the independence axiom is satisfied the design is reviewed regarding its constraints. If the design solution violates the constraints a new solution has to be searched for. If all constraints are fulfilled the proposed solution process will be stopped and the solution can be designed in detail. Omitting the review of the design regarding axiom two, may bear the risk of not finding the best design solution, but the functional independence of the design is guaranteed at least. This provides a certain degree of robustness of the design solution. In fact this represents an improvement in comparison to making design decisions only based on experience of the designer.

The following procedure is suggested:

1. Analyze the design task.
2. Formulate constraints that are generally valid for the design task.
3. Decompose the design problem by creating a hierarchical view of the FRs and DPs on the highest and therewith most abstract levels.
4. Transform the hierarchical view to a design matrix to check dependencies.
5. Find standard solutions for the lower level problems with the use of catalogues, literature or by experience.

4 USE CASE: DESIGN OF A MOBILE PLATFORM TO EASE ASSEMBLY OPERATIONS FOR WORKERS

A mobile platform is a common way to ease assembly operations for workers. It is a transporting system to transport workmen parallel to a conveyor and with the same speed. Systems like this provide mainly two advantages. First of all working conditions are improved because the worker has no longer to move sideways while doing assembly operations and he has not to move back to the subsequent product which is a car in the considered example. Therefore the individual movements of the worker are shortened and he can perform his tasks just as if standing still. In addition the worker is able to carry out pre-assembly operations on the platform when they are moved back to the next car. Due to this an economical gain is achieved which represents the second advantage.

To ensure the platform is moving at the same speed as the assembly line, the platform is linked to the conveyor. This linking can be realized mechanically. On the left side in Figure 4 an example of a mobile platform is given, on the right side the process steps are schematically visualized. Initially the platform is linked to the conveyor and moves parallel to the assembly line at its speed. When the platform reaches the end it gets unlinked and moves back to the starting point but at a higher speed. Then the process starts from the beginning.

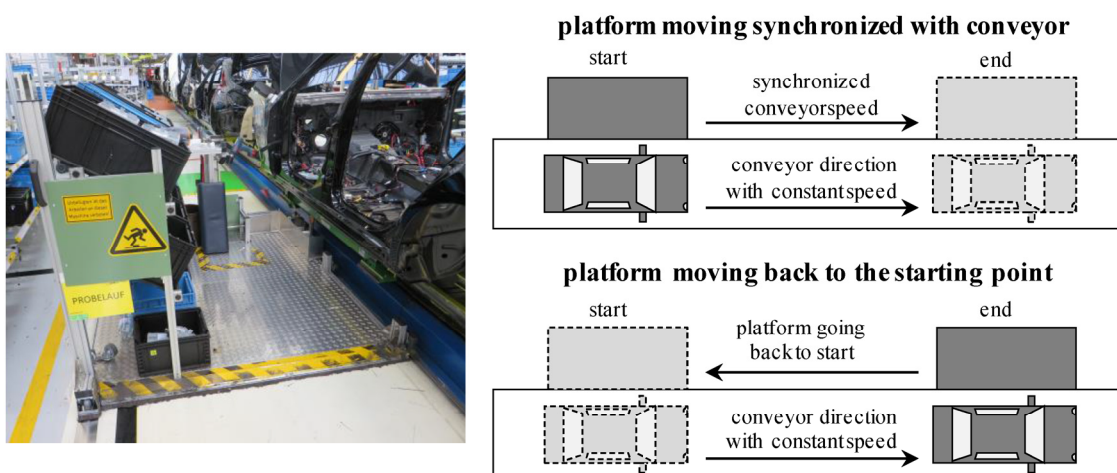

Figure 4. Mobile platform and corresponding process steps

4.1 Analysing the Design Task

Analysing the design task is executed in two steps beginning with the formulation of constraints of the design. In this case the constraints are the following:

- C 1: minimal investment costs
- C 2: minimal design height
- C 3: minimal fixed installations
- C 4: minimal linking to existing surroundings

These constraints have to be considered all the time of the development process. After this the functional requirements and the corresponding design parameters have to be fixed. Thereby the selection of the design parameters is done on base of the independence axiom and by considering the formulated constraints. For the whole tree only four hierarchical levels seem to be sufficient. These levels are gained by switching from the functional domain to the physical domain and vice versa.

In Figure 5 a section of the hierarchical tree of the functional and physical domain for the design task is visualized. It is clearly recognizable how the DP of the higher level influences the FRs of the lower levels. Finding DP 1 (mobile platform) leads inevitably to the question what functions this platform should fulfil. For example this is the FR to move the platform linear, i.e. parallel to the assembly line. This can be done by a drive unit with a mechanical guidance system. On the next lower level it is asked what this drive unit and guidance system has to look like. For the guidance system it is FR 1.2.3 which states that only linear movement should be allowed. This requirement can be fulfilled by DP 1.2.3 that is a guide rail paired with a matching wheel flange role. On the lowest level you can find the leaves of the hierarchical tree which contain the most detailed FRs. In this case these are the requirements of the rail and its wheel. For this you have three FRs which are taking transversal forces in order to keep the platform in line, avoiding trip hazards as an safety aspect and compensating ground unevenness. The design parameters that fulfil the FRs are the following:

- the height of the cross section of the guide rail
- the geometry of the cross section of the guide rail which is chosen as half-round in order to avoid trip hazards
- a spring between the wheel flange role and the platform in order to compensate the unevenness of the flooring

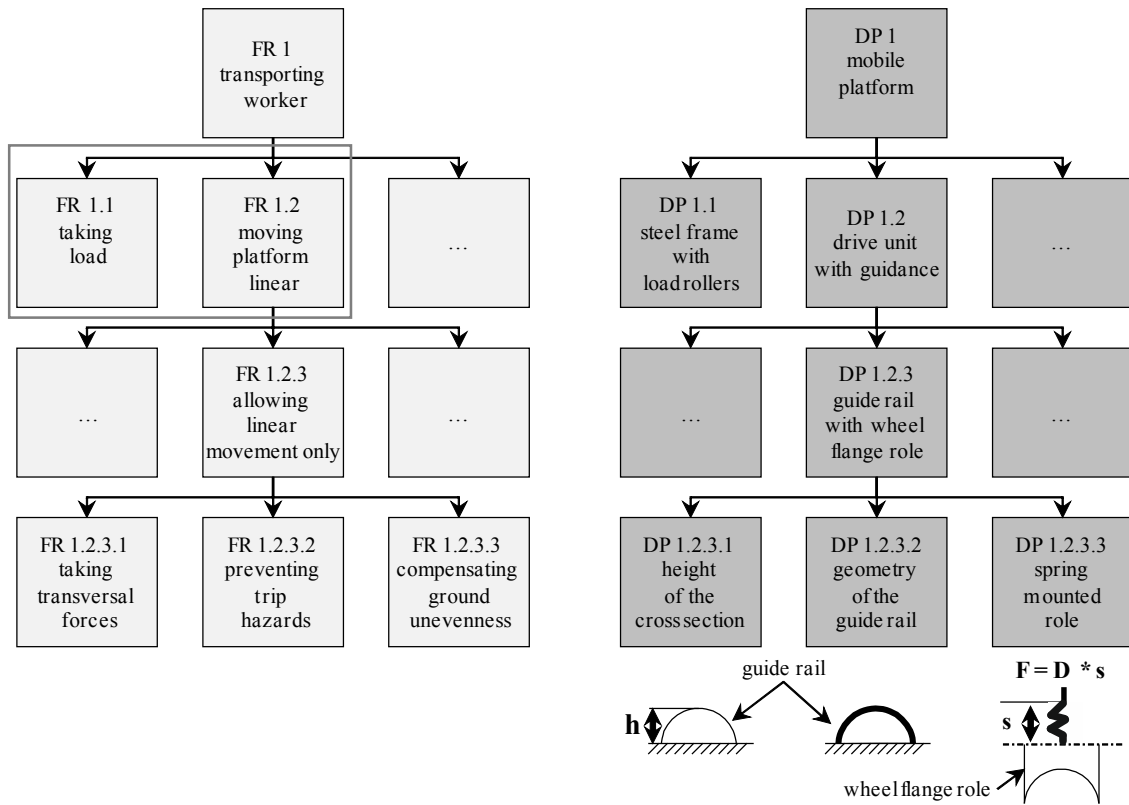

Figure 5. Hierarchical tree of functional and physical domain for the design task

If the level of the leaves gets transformed into the design matrix you can note that this is a decoupled system. The origin of this coupling resides in the fact that changing the geometry of the guide rail influences the bearable transversal forces. But this coupling does not matter because it can be fixed by changing the order of the FRs (Figure 6). First of all the geometry of the guide rail should be defined. After this the proper height can be determined to take enough transversal forces to keep the platform parallel to the assembly line. By keeping this order the system gets controllable.

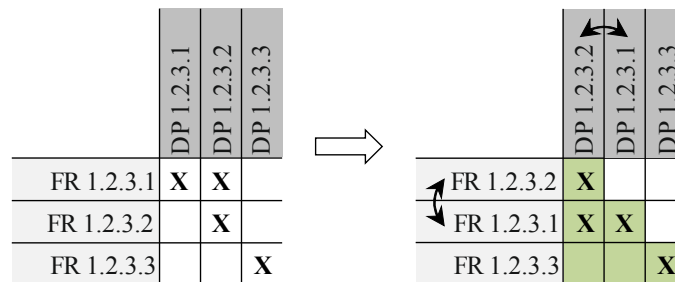

Figure 6. Transformation of the design matrix for the guide rail with wheel flange role

Repeating the transformation of the hierarchical view to the design matrices helps to identify and to minimize coupling. The result of this work is an uncoupled or mostly decoupled conceptual design that satisfies at least axiom 1. The application of axiom 2 is not carried out because the solution space is already reduced enough by considering axiom 1. In general this facilitates the usage of axiomatic design enormously and saves time.

4.2 Detailed Design

To reach a detailed design the conceptual design gets refined. In the example of the guide rail and the wheel flange role the following steps are done: instead of expanding the hierarchical tree to the lowest levels by clarifying all of the details up to the last machine element, the designer intuitively solves the problems. For example the designing of the bearing and mounting of the wheel flange role can be done by using catalogues. This is a faster way of reaching the objective because it is not necessary to apply

the two axioms on standard solutions of little or no significance like this. The result of this step is a model like shown in Figure 7.

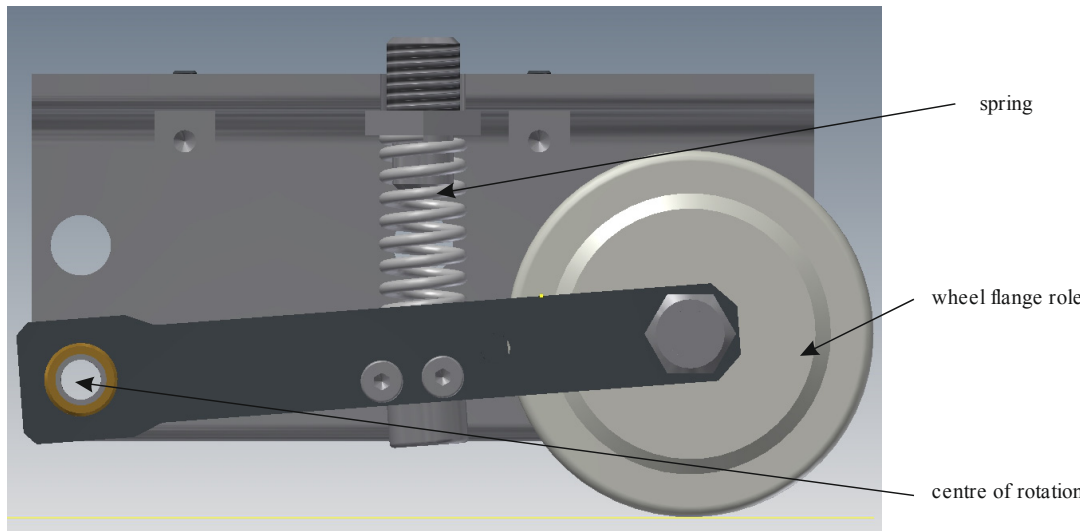

Figure 7. Model of the spring mounted wheel flange role

4.3 Evaluation

Guide rails in combination with wheel flange roles are a familiar solution for allowing a linear displacement only. Nonetheless in some cases the combination of the rail and the role makes problems in that way that one of these elements gets damaged during operation. It was experienced that this problem is related to the fact that the wheel flange roles were weight-loaded designed. In other words the functional requirement ensuring a linear movement was not kept independently from the requirement of taking a specific load. This mistake has been avoided by the here presented approach. Already in the second level of the hierarchical tree these two functional requirements have been stated in two different branches. This presentation helped to keep the independence of both functions on a high level.

Furthermore the selection of the guide rail geometry as well as the wheel flange role geometry can be assessed as a good decision. Instead of choosing a triangular or rectangular cross section a half-round cross-section was chosen. This was guaranteed by fulfilling the demanded functional requirement FR 1.2.3.2. “preventing trip hazards”. For the same reason it has been avoided to choose the negative form which is mounted above the ground level. The alternative possibility of choosing any form which is sunk in the ground has been overruled because of violating two of the formulated constraints. First violated constraint is the claim for “minimal investment costs” which is not maintained by additional floor work. Second constraint is the demand for “minimal fixed installations” that could not be fulfilled because of the need of milling operations in the flooring (Figure 8).

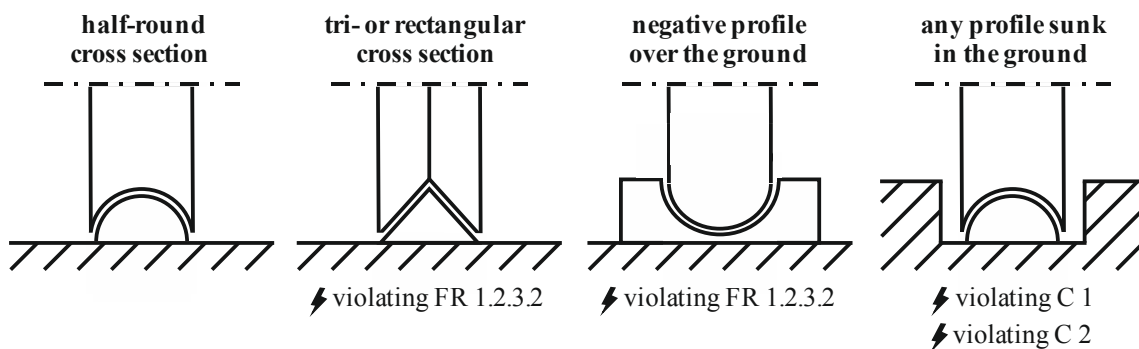

Figure 8. Wheel flange role principles

5 DISCUSSION

In literature many times Axiomatic Design Theory is criticized for not stimulating creativity because it would only help to identify a proper solution instead of helping to find a new solution. Despite of this point of criticism AD is a good design theory because the structured procedure of AD not only helps to identify the best solution of a given set of solutions. It also enables the designer to analyze the design task by some degree of abstraction which facilitates the creation of new ideas.

The described approach tremendously facilitates the application of a grown and sophisticated design methodology. Even so it provides a structured procedure for engineering design in industrial companies. In fact it limits the use of Axiomatic Design to the application of only the so called independence axiom. The question is justified whether this concept still ensures to reach the goal of finding a good solution for a given design task.

Although the complexity of the design task given in the use case is relatively small compared to complex assembly systems (e.g. for pre-assembling of passenger car doors), already positive effects can be recognized as demonstrated. In a nutshell it can be stated that this approach may not guarantee to reach the best design from every point of view but at least it helps to improve designs in the industry by supporting the designer to think of independent functional requirements.

All the aspects of AD have their legitimation and the proposed approach should not be seen as an antithesis to Suh's work. It is imaginable to use the shown procedure generally as first steps into a complex design methodology and as an assistance to overcome inhibitions. Another possibility is to use this simplified procedure as a kind of approximation in early design phases which can be detailed to a full AD approach during the following design steps. In some other cases it can be sufficient to carry out the mentioned shortened approach.

6 CONCLUSION AND PERSPECTIVE

In summary an Axiomatic Design based approach is shown that facilitates the application of this methodology in everyday working life of engineers. AD is chosen because of its clear visualisation of dependencies of functional requirements which is a good control for designers if their design fulfils the principles of a good design. Limiting on the first axiom – the independence axiom – attention gets focused on keeping the independence of the functional requirements on the highest levels. This simplified approach which involves little effort already helps to get maybe not the best but a quite good and robust design. Setting up the design matrix for the leaves of the hierarchical tree helps to check if the axioms and constraints are maintained. For the lowest levels no hierarchical tree and no design matrix was set up because solutions for these problems are mostly standard solutions that can be taken from standard catalogues, from experience or from literature. This proceeding saves time and extra work. Possible positive effects are illustrated by a use case dealing with the design of a mobile platform to ease assembly operations for workers. Finally the efforts of the approach were content of a critical discussion.

For the future it is easily conceivable to create a kind of catalogue or database for design tasks which appear more often. The functional requirement of “allowing linear movement” for example is a common design task. Consequently it is a good idea to keep the solution provided in form of the guide rail with a spring mounted wheel flange role in mind and to store the related hierarchical tree. Further research is required to ensure that this approach provides an improvement of engineering design to industrial companies. The next step is the application of the proposed approach to a more complex use case.

REFERENCES

- Altshuller, G. (1988) Creativity as an Exact Science. New York: Gordon and Breach.
- Baxter, J.E., McKay, A., Agouridas, V. and de Pennington, A. (2002) Supply Chain Design: An Application of Axiomatic Design, Second International Conference on Axiomatic Design, Cambridge, 10.-11.06.2002: Institute for Axiomatic Design.
- Hubka, V. and Eder, W.E. (1992) Einführung in die Konstruktionswissenschaft. Berlin-Heidelberg: Springer.
- Mann, D. (2002) Axiomatic Design and TRIZ: Compatibilities and Contradictions, Second International Conference on Axiomatic Design, Cambridge, 10.-11.06.2002: Institute for Axiomatic Design.

- Marchesi, M., Fernandez, J.E., Matt, D.T., Kim, S.-G. (2014) Axiomatic Design Approach for the Conceptual Design of Sustainable Buildings, The Eighth International Conference on Axiomatic Design, Caparcia, 24.-26.09.2014, Caparcia: ICAD2014, pp. 25-33.
- Martin, S.B. and Kar, A.K. (2002) Axiomatic Design for the Development of Enterprise Level E-Commerce Strategies, Second International Conference on Axiomatic Design, Cambridge, 10.-11.06.2002: Institute for Axiomatic Design.
- Nordlund, M., Tate, D. and Suh, N.P. (1996) Growth of Axiomatic Design through Industrial Practice, 3rd CIRP Workshop on Design and Implementation of Intelligent Manufacturing Systems, Tokyo, 19.-21.06.1996: The University of Tokyo, pp. 77-84.
- Shin, G.-S., Yi, J.-W., Yi, S.-I., Kwon, Y.-D., Park, G.-J. (2004) Calculation of Information Content in Axiomatic Design, The Third International Conference on Axiomatic Design, Seoul, 21.-24.06.2004, Seoul: ICAD2004.
- Suh, N.P. (1990) *The Principles of Design*. New York: Oxford University Press.
- Suh, N.P. (2001) *Axiomatic Design – Advances and Applications*. New York: Oxford University Press.
- Tate, D. and Mats, N. (1995) Synergies Between American and European Approaches to Design, First World Conference on Integrated Design and Process Technology, Austin, 07.12.-09.12.1995: Society for Design and Process Science, pp. 103-111.
- Weber, C. (2005), “CPM/PDD - An extended theoretical approach to modelling products and product development processes”, 2nd German-Israeli Symposium on Advances in Methods and Systems for Development of Products and Processes, Stuttgart, 07.-08.07.2005: Stuttgart: Fraunhofer-IRB-Verlag, pp. 159-179.