

# PRE-SELECTION OF HYBRID ELECTRIC VEHICLE ARCHITECTURES DURING THE INITIAL DESIGN PHASES

Carlos Gorbea<sup>1</sup>, Ernst Fricke<sup>2</sup> and Udo Lindemann<sup>3</sup>

<sup>1</sup> BMW Group/Technische Universität München

<sup>2</sup> BMW Group and <sup>3</sup> Technische Universität München

*Keywords: Hybrid Electric Vehicles, Product Architecture, Design Structure Matrix*

## INTRODUCTION

The Hybrid Electric Vehicle (HEV), one that uses an internal combustion engine and an electric motor to achieve motion, has been around for more than a century and is now making a comeback. Automakers are now placing an increased focus in deriving methodologies to assist in HEV development activities that seek to deliver cars with better fuel efficiency, less pollution, at no compromise to the performance qualities and comfort of conventional automobiles. The complexity involved with such a system requires a structured development process.

A five step process that utilizes Design Structure Matrices and Domain Mapping Matrices is outlined in this paper to aid in the pre-selection of HEV architectures during the initial phases of product development; these are:

1. Develop a goal oriented design statement.
2. Analyze possible HEV architectures with the aid of matrices.
3. Use simulation to evaluate HEV architectures.
4. Conduct sensitivity and risk-opportunity analysis on considered architectures.
5. Select HEV architectures for further detailed study that best meets goals.

The aim of these 5 steps is to reduce the varied field of architectures to only goal oriented relevant solutions. The process is not intended to describe a method in finding one optimal solution.

## 1 DEVELOP A GOAL ORIENTED DESIGN STATEMENT

HEV goals are derived from a myriad of customer requirements, government regulations, influences from competitor's products, and the firms own market strategy. At this step it is important to structure the design problem into a design statement that exhibits the following four key items:

**Objectives** – Items designers would like to maximize or minimize as overall goals

**Design Variables** – Items which developers can change while designing the product

**Parameters (Constants)** – Items that must be considered fixed while developing the product

**Constraints** – Items that limit the design and can be expressed as inequalities.

By identifying these four items [5], designers generate a good idea of the degrees of freedom available in the new design.

## 2 ANALYZE POSSIBLE HEV ARCHITECTURES

The focus in this step is to generate an understanding of possible HEV architectures. Product architecture refers to the arrangement and mapping of a product's functional elements to its physical components, and the specification of interfaces between physical components [1]. DSMs and DMMs were selected for their systematic approach in identifying links within both the functions and components domains, as well as links between both domains. By filling in the matrices that follow, we gained an understanding on: 1. How can functional modules be created?; 2. How components modules relate to these functional modules? 3. Which architectures can be discarded from consideration based on functional limitations?

## 2.1 Build Components DSM and Functions DSM

We constructed a components DSM and a functions DSM for various HEV architectures to study relationships within each domain. With the help of a clustering algorithm, we developed modules of functions and components that helped us achieve a high level of abstraction for our model with enough detail to differentiate between HEV architectures. For example, instead of looking at functionalities of detailed engine parts such as pistons, crankshaft, and so on, we decided to set model boundaries at a more abstract level such as the basic function of an engine in converting fuel to mechanical energy. Figure 1 shows an example of a functions DSM for a series hybrid architecture that was used to determine function modules.

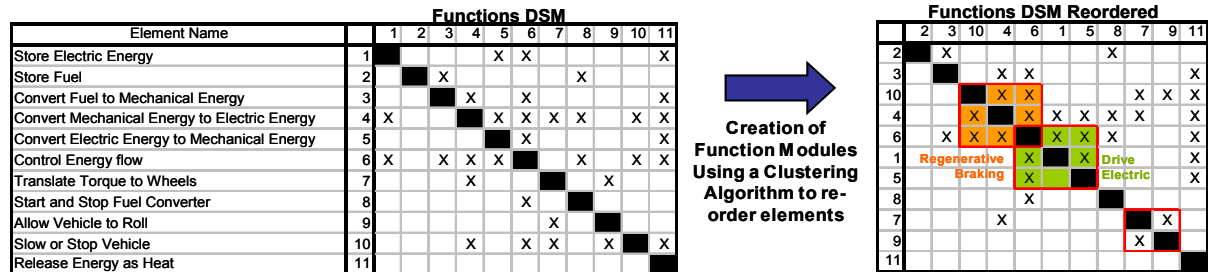

Figure 1. Functions DSM before (left) and after (right) clustering algorithm (© Loomeo Software)

## 2.2 Build Component – Function DMM

Once our model boundaries were set, relationships across functions and component domains were mapped. These mappings clearly reveal which components are well integrated to the HEV architecture by looking at the number of functions they influence. The level of coupling of components and functions has a direct effect on the product’s design flexibility and the capability to reuse design modules across product lines [2].

A matrix representation of a function-component domain mapping for a series hybrid architecture is shown in figure 2. Because the series hybrid uses the internal combustion engine solely for generating electricity it is decoupled from the drive train. The Multiple Domain Matrix (MDM) representation of the DSMs and DMM allows designers to see ‘hidden’ feedback loops between the component and functions domains [3] as well as the level of direct and indirect coupling in the off diagonal DMMs.

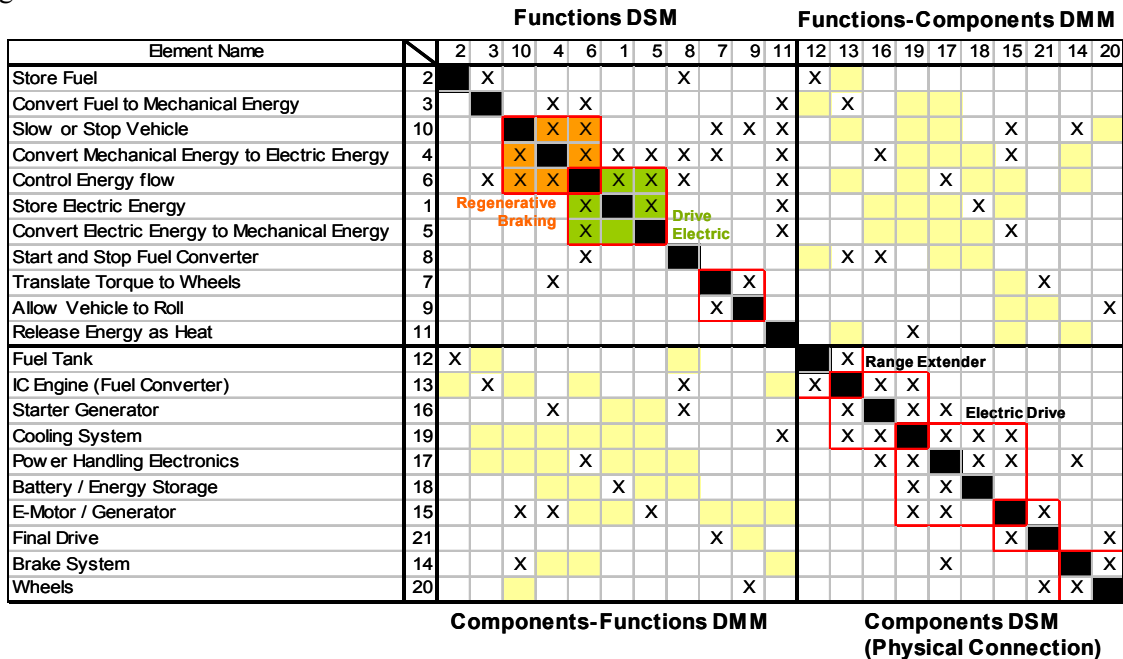

Figure 2. MDM showing DSM clustering, DMM direct and indirect links

## 2.3 Consolidate Results

We ordered architectures that achieved a specific functional set by applying a similar MDM (DSM/DMM) analysis to parallel, series and power split architectures we analyzed. Based on the goals

defined in step 1, the developer should determine what functions are relevant to the design and focus only on architectures that fulfil the functional set forth by the goals and requirements.

### **3 USE SIMULATION TO EVALUATE HEV ARCHITECTURES**

Because overall vehicle goals such as minimizing fuel consumption and emissions result from vehicle dynamics, the use of simulation support is required in testing the functional behaviour of our selected models after step 2. The aim of the simulation is to generate a trade space mapping of HEV architectures to overall vehicle goals, such that Pareto optimal solutions can be identified [4].

The simulation tool can be understood as a black box that takes architectures with a variety of component sizes as input and provides as output overall vehicle goals such as fuel consumption, emissions, weight, driving performance and cost for each architecture variation [7].

### **4 CONDUCT SENSITIVITY ANALYSIS AND DETERMINE RISK – OPPORTUNITY OF ARCHITECTURES**

Pareto dominant architectures resulting from step 3 can vary based on assumptions made within the simulation process. It is important to conduct a thorough sensitivity analysis, where model inputs values are changed in order to determine their effect on the overall goals and distinguish what risk potentials exist. For example, if one of the overall goals is to minimize cost, some vehicle components still under development such as the HEV battery system might have been estimated poorly in the model.

### **5 SELECT HEV ARCHITECTURES FOR FURTHER DEVELOPMENT**

Based on the knowledge acquired within steps 1-4, a decision must be made in selecting a particular HEV architecture for further development. This entails weighing the risks and opportunities defined in step 4 for each architecture option and determining if the original goals can be achieved – the decision criteria in this case are directly taken from the goals and constraints sets in step 1. The decision made must be properly documented to allow transparency in the selection process. The 5 steps outlined will naturally exhibit iteration as more knowledge is generated during the design.

### **6 TOPICS FOR FURTHER RESEARCH**

Ongoing research focuses on determining cost-benefit relationships that affect the efficient dynamical operation of the vehicle across the HEV architecture spectrum. Requirements for additional functionality exhibit a direct impact on cost for both manufacturers and consumers. For example, basing vehicle goals on fuel consumption per dollar spent can favor a micro hybrid with reduced purchasing costs, whereas emissions per kilometer favors a full or plug-in hybrid at the expense of battery replacement costs. Such goal conflicts must be addressed in a methodical way that allows transparency in making decisions [6].

### **REFERENCES**

- [1] K.T. Ulrich, “The Role of Product Architecture in the Manufacturing Firm”, *Res Policy* 24(3) (1995) 419-440
- [2] E. Fricke and A. Schultz, “Design for Changeability (DFC): Principles to Enable Changes in Systems Throughout Their Entire Lifecycle”, *Systems Engineering*, Vol. 8, No.4, 2005
- [3] M. Eichinger, M. Maurer, U. Pulm and U. Lindemann “Extending Design Structure Matrices and Domain Mapping Matrices by Multiple Design Structure Matrices.” In *Proceeding of the 8<sup>th</sup> Biennial Conference on Engineering Systems Design and Analysis (ASME)*. Torino, Italy, July 4-7 2006
- [4] Smaling R., de Weck O., “Assessing Risks and Opportunities of Technology Infusion in System Design”, *Systems Engineering*, 10 (1): 2007
- [5] O. de Weck and Willcox, “Multidisciplinary Design and Analysis Problem Formulation”, MIT OpenCourseware, Lecture 2, ESD.77, 2004
- [6] U. Lindemann, “A Vision to Overcome “Chaotic” Design for X Processes in Early Phases, *International Conference on Engineering Design, ICED’07*, August 2007
- [7] K.B. Wipke, M.R. Cuddy, *Using an Advanced Vehicle Simulator (ADVISOR) to Guide Hybrid Vehicle Propulsion System Development*, 1998.

\*Contact: Carlos Gorbea, BMW Group / Technische Universität München,  
E-mail: carlos.gorbea@pe.mw.tum.de, carlos.gorbea@bmw.de

## 9TH INTERNATIONAL DSM CONFERENCE

# Pre-selection of Hybrid Electric Vehicle Architectures during the Initial Design Phases



Hybrid Vehicle Market Growth Trends 2006

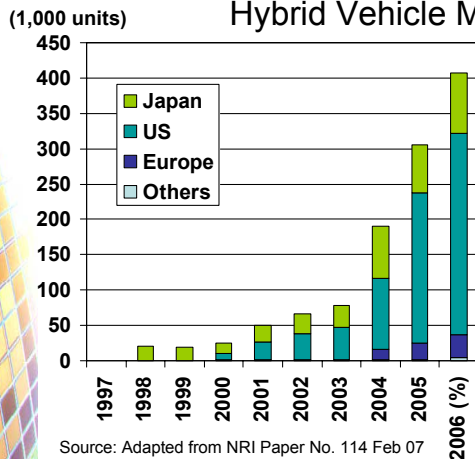

- The size of the hybrid market has been significantly increasing every year
- Large room for market growth – Hybrid less than 1.5% of the world market

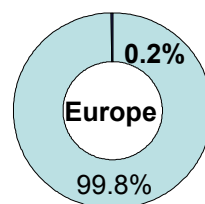
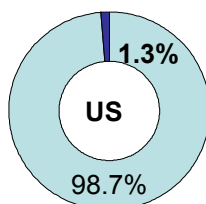
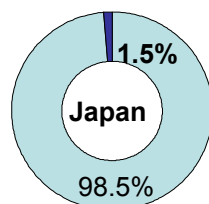

Ratio of Hybrids among Car Sales in Japan, the US and Europe (2006)

## A Five Step Model is Proposed for Pre-Selecting the best Architectures based on Development Goals

- Step 1:** Develop a goal oriented design statement
- Step 2:** Analyze possible HEV Architectures with the aid of matrices
- Step 3:** Develop an architecture trade study using simulation
- Step 4:** Conduct a sensitivity analysis and determine risk-opportunity of the architectures considered
- Step 5:** Select HEV architecture for further development

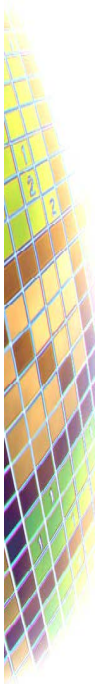

## Step 1: Prioritize goals and structure the problem Clearly stating objectives, design variables, parameters and constraints will allow for transparency in the solution search

In multi-objective design - structure the problem into four basic elements:

- Objectives** – Items we would like to maximize or minimize in order of priorities
- Design Variables** - Items which developers can change to create a Product
- Parameters (Constants)**- Items that are considered fixed in developing the future product
- Constraints**-Items that limit the design and can be expressed as inequalities

### Design Statement:

Find HEV architectures by **minimizing lifecycle costs and fuel consumption** by selecting **engine type, engine size, battery type, battery pack capacity, E-motor power rating, starter/generator configuration, braking system, hybrid control unit algorithm and transmission type**; subject to performance in **acceleration time, weight limits, sales price increase from base model** and **maintaining passenger volume and trunk volume** to that of a 2007 vehicle.

Objective Set  
 Design Variables  
 Constraints  
 Parameters

Source: Adapted from O. DeWeck and K. Willcox, MIT

## Step 2: HEV Product Architecture Analysis Develop System Boundaries Analysis of Functions, Components and Configuration

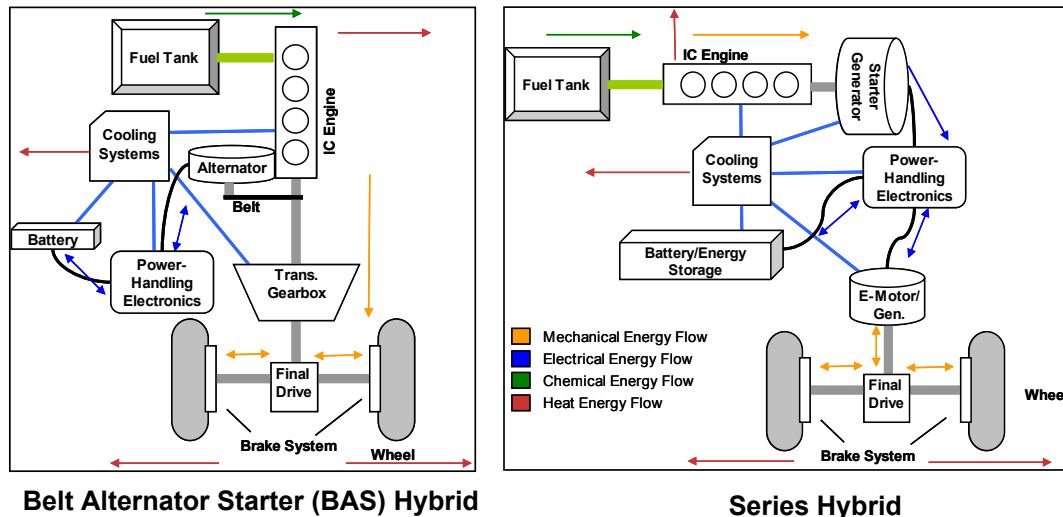

**Belt Alternator Starter (BAS) Hybrid**

**Series Hybrid**

Example of two different hybrid architecture models with energy flow depictions

## Step 2.2: Build Function and Component DSM Developing Architecture based Functional Modules

**Functions DSM**

Element Name	1	2	3	4	5	6	7	8	9	10	11
Store Electric Energy	1				X	X					X
Store Fuel	2		X						X		
Convert Fuel to Mechanical Energy	3			X	X						X
Convert Mechanical Energy to Electric Energy	4	X			X	X	X	X	X	X	
Convert Electric Energy to Mechanical Energy	5					X					X
Control Energy flow	6	X		X	X	X			X	X	X
Translate Torque to Wheels	7			X						X	
Start and Stop Fuel Converter	8					X					
Allow Vehicle to Roll	9						X				
Slow or Stop Vehicle	10			X	X	X		X			X
Release Energy as Heat	11										

'X' depict input relationships across column elements and output relationships across row elements – (e.g. element 3 takes input from 2 and 6; outputs to 4, 6 and 11).

Reordered using simple clustering algorithm (© Loomeo)

Element Name	2	3	10	4	6	1	5	8	7	9	11
Store Fuel	2	X							X		
Convert Fuel to Mechanical Energy	3			X	X						X
Slow or Stop Vehicle	10			X	X			X	X	X	X
Convert Mechanical Energy to Electric Energy	4	X		X	X	X	X	X	X	X	
Control Energy flow	6	X	X	X	X	X	X	X	X	X	
Store Electric Energy	1	Regenerative Braking		X	X	X	Electric Drive				X
Convert Electric Energy to Mechanical Energy	5			X	X						X
Start and Stop Fuel Converter	8				X						
Translate Torque to Wheels	7		X							X	
Allow Vehicle to Roll	9								X		
Release Energy as Heat	11										



## 2.4 Consolidate Results

Which Architectures will serve our needs?

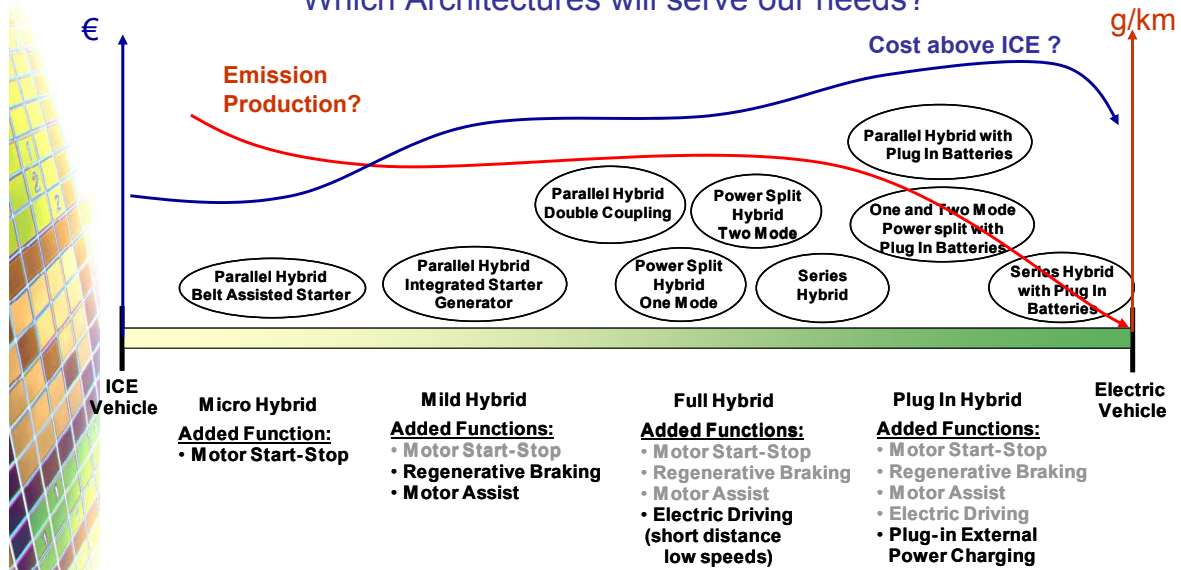

The Multiple Domain Matrix (DSM/DMM) identifies functional and component modules

## Step 3: Architecture Trade Study using Simulation

Simulation Goal is to identify non-dominated architectures

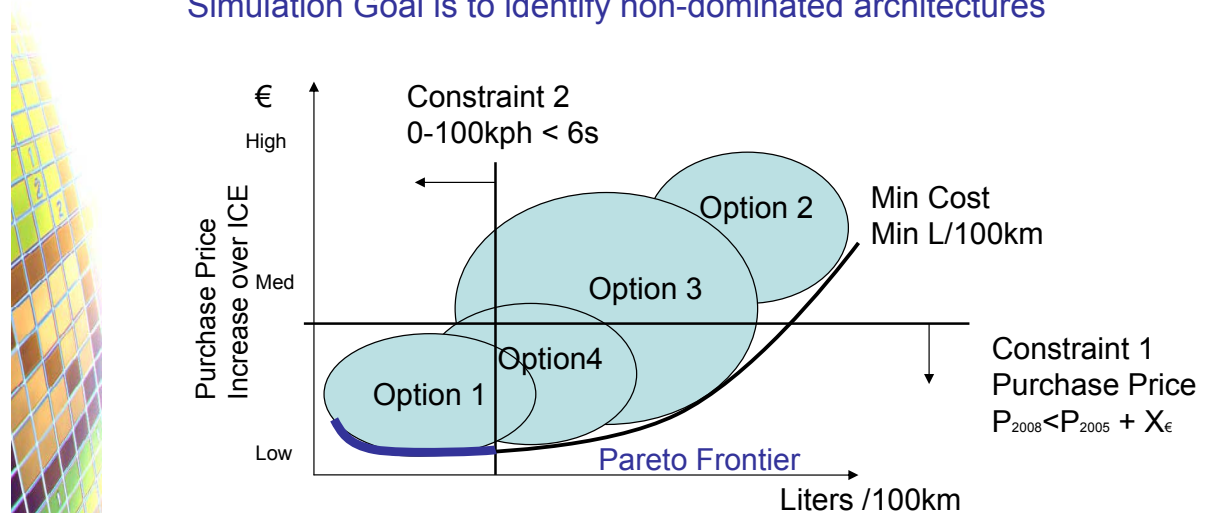

Simulated vehicle concepts in the solution space allow us to identify 'non-dominated' architectures



## Step 4: Sensitivity analysis and Architecture Risk-Opportunity

- The **Trade space** analysis provides only a starting point for the selecting the 'right' architecture. The process does not bias any particular architecture.
- A **sensitivity** analysis will allow developers to distinguish how sensitive the Pareto frontier is to changes in the selected variable's range or how a change in a particular parameter will influence the trade space results.
- The **risk-opportunity** analysis looks at particular architectures to distinguish what is the chance that the architecture will or will not meet intended design requirements
- Selected architectures for further study need further **decomposition** into a more detailed level.

## Step 5: Select Architectures for further Development

- Making an architecture selection decision requires:
  - A **cross-functional team** with adequate and equal knowledge of all architectures being considered
  - Identifying **decision criteria** based on the objectives and constraints sets
  - **Transparency** in weighing and setting priorities
  - **documentation** using a matrix that clearly includes the key decision points agreed to be the decision team

## Summary

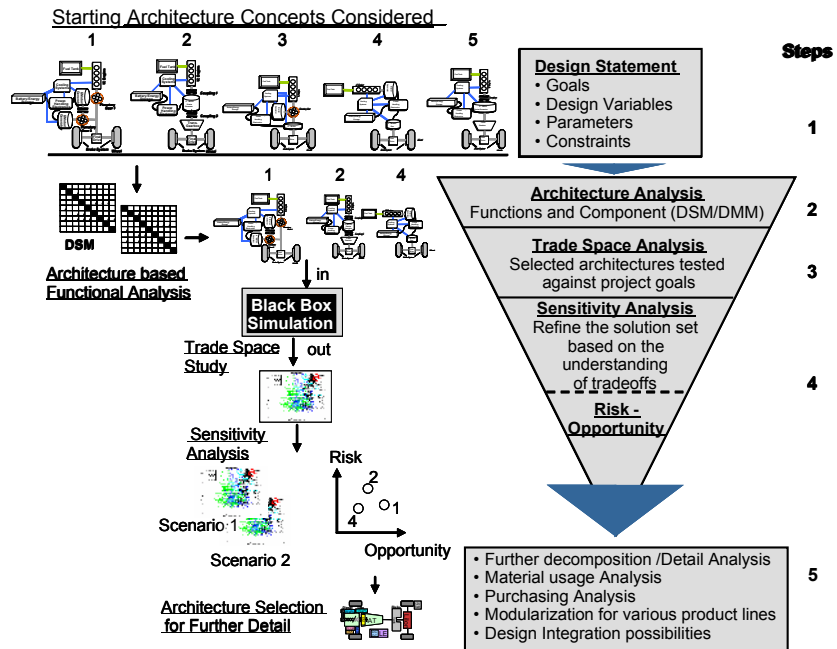

## Work in Progress

- MDM linking between Requirements-Functions-Components-Cost
- Hybrid Vehicle Architecture Cost-Benefit Analysis
  - Example: Diesel Micro Hybrid vs. Otto Full Hybrid
    - Fuel Consumption
    - Emissions
    - Weight
    - Cost
- Integrating Cost Modeling to Simulation Software
- Plug in Hybrid Architectures

